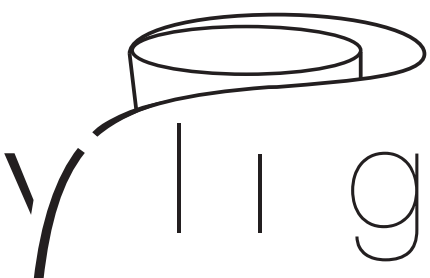

l a y l i g h t

The logo for 'laylight' features the word in a lowercase, sans-serif font. The letter 'y' is uniquely designed as a speech bubble, with a curved tail that loops back to form a cylindrical shape, resembling a microphone or a light fixture.

LISTINO PREZZI 2010
PRICE LIST 2010

Condizioni generali di vendita

Il conferimento dell'ordine vale come esplicita accettazione delle condizioni di vendita sotto riportate:

1. VALIDITÀ DEI PREVENTIVI: è di 60 (sessanta) giorni dalla data di emissione, salvo diritto di revoca anticipato da parte della RESSTENDE Srl. Eventuali variazioni a quanto espresso in preventivo per misure, quantità, tipologie e materiali impiegati daranno luogo ad una conferma d'ordine aggiornata nei prezzi e nei termini di consegna.

2. La fabbricazione dei materiali viene eseguita in base alla distinta delle misure ed ai dati tecnici forniti dalla Committente o dalla Direzione Lavori. Nei casi contrattualmente concordati, il rilievo delle misure esecutive potrà essere effettuato direttamente da nostro personale specializzato.

3. Le tabelle dei prezzi per i tessuti fanno riferimento alla misura finita (misura telo = misura finita +20 cm in altezza per attacco rullo). La misura finita definisce le dimensioni di fabbricazione al netto delle tolleranze di applicazione e costituisce elemento di calcolo per la fatturazione del prodotto. La RESSTENDE Srl declina ogni responsabilità a fronte di trasmissioni di misure esecutive non rispondenti a quanto sopra precisato.

4. TRASPORTO: la fornitura si intende in porto franco con addebito in fattura del 4% per spedizione (costo minimo di trasporto 9,60 € IVA inclusa) alla sede della Committente entro i confini nazionali. La merce viaggia senza assicurazione, a rischio della Committente (Art. 1693 CC).

5. IMBALLO: incluso.

6. TERMINI DI CONSEGNA: per prodotti "standard", 2-3 settimane dal ricevimento della nostra conferma d'ordine firmata; in ogni caso i termini di consegna sono da ritenersi indicativi e non di rigore. Eventuali ritardi di consegna non comporteranno alcun risarcimento, penalità o annullamento dell'ordine salvo accordi contrattuali espressamente pattuiti. I reclami verso gli spedizionieri - per errore, tassazioni, ritardi, avarie, rotture, ecc. - spettano all'acquirente con esonero della RESSTENDE Srl da ogni responsabilità: pertanto deve essere dichiarata la "riserva" al momento dello scarico direttamente all'incaricato che effettua la consegna.

7. GARANZIA: viene fornita per anni 2 (due) a decorrere dalla data di consegna ed è valida per i soli materiali, inclusi tutti i componenti elettrici. Detti componenti dovranno essere installati e collegati secondo le norme CEI e comunque secondo le normative impiantistiche e di sicurezza vigenti al momento dell'installazione: diversamente la garanzia verrà considerata decaduta. Durante il periodo di garanzia non si accettano richieste di rimborso spese su riparazioni effettuate direttamente, senza nostra preventiva presa visione o autorizzazione scritta, ed in ogni caso la garanzia riguarda vizi di fabbricazione del prodotto e non problemi derivanti dall'installazione di terzi.

8. RECLAMI: dovranno essere inoltrati per iscritto entro giorni 8 (otto) dal ricevimento della merce: diversamente non potranno essere presi in considerazione. Eventuali resi saranno accettati solo previa autorizzazione scritta della RESSTENDE Srl. Eventuali difetti o anomalie di funzionamento dei materiali forniti dovranno essere segnalati per iscritto alla RESSTENDE Srl, la cui responsabilità è limitata alla sostituzione delle merci difettose o di parte delle stesse, escluso ogni diritto alla risoluzione del contratto o alla riduzione del prezzo o ad ogni risarcimento del danno. Oneri quali trasferte, smontaggi, trasporti, rimontaggi, ecc. sono comunque esclusi dalla presente garanzia e non potranno quindi esserci addebitati. Qualora la fornitura comprenda la "Posa in Opera" la RESSTENDE Srl, previo sopralluogo di un proprio incaricato, valuterà la natura dei difetti in rapporto alle condizioni di garanzia e provvederà alla sostituzione dei componenti in garanzia nel tempo più breve possibile consentito da tale operazione.

9. ANNULLAMENTO DI ORDINI: la RESSTENDE Srl non accetta annullamenti quando il materiale degli stessi è già in fase di lavorazione.

10. FATTURAZIONE: decorre dall'approntamento della merce e dall'emissione del documento di trasporto.

11. PAGAMENTO: i termini e le condizioni di pagamento sono quelli precedentemente concordati e sottoscritti dalla Committente e dalla RESSTENDE Srl. In caso di fornitura con posa in opera e decorrenza del pagamento a fine lavori, qualora il montaggio non possa avvenire per cause non imputabili alla RESSTENDE Srl, si procederà alla fatturazione del materiale dedotto l'importo della posa che verrà fatturato successivamente a fine lavori

12. MANCATO PAGAMENTO: il mancato rispetto dei termini di pagamento concordati comporterà un interesse di mora corrispondente al tasso bancario corrente praticato alla RESSTENDE Srl.

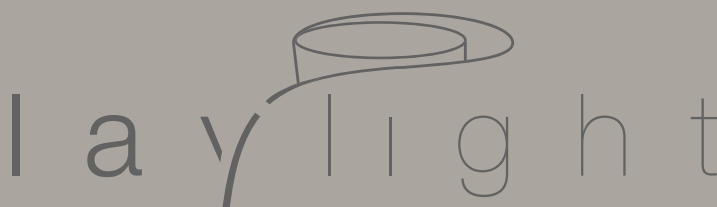

lay light

13. POSA IN OPERA: Qualora la fornitura la comprenda, si precisa che da detta prestazione sono escluse tutte le opere murarie, di saldatura, la predisposizione degli infissi al passaggio dei comandi, gli impianti ed i collegamenti elettrici: detti oneri si intendono specificatamente a cura e sotto la responsabilità della Committente. Sarà inoltre cura della Committente fornire in cantiere la disponibilità di un locale adeguato allo stoccaggio ed alla custodia del materiale da posare, assumendosi ogni responsabilità per la sua integrità e conservazione. La Committente dovrà mettere il personale di posa in condizione di operare in modo continuativo: periodi di inoperosità del nostro personale di posa non imputabili alla RESSTENDE Srl saranno addebitati e fatturati a consuntivo.

14. COLLAUDO: Se espressamente convenuto, il collaudo delle opere di nostra competenza dovrà essere effettuato entro 10 (dieci) giorni dall'ultimazione della posa che verrà comunque certificata mediante apposito verbale compilato dal personale di posa e sottoscritto dalla Committente o dalla sua D.L. La Committente, sovrascrivendo il verbale di fine posa, certifica che i lavori sono stati eseguiti ed ultimati a regola d'arte e rilascia il proprio benestare alla fatturazione.

15. Per qualsiasi controversia è competente il Foro di Milano.

General terms and conditions of sale

Unless otherwise stated at the instant of ordering, the present terms and conditions of sale are considered to be explicitly accepted:

1. QUOTATION VALID for 60 (sixty) days from date of emission, RESSTENDE Srl retains the right to earlier withdrawal. Any variations in dimensions, quantity, model or materials employed, with respect to the original quotation, may result in updated prices or terms of delivery, these will however be clearly stated in the order confirmation.

2. The manufacture of the blind systems is carried out in accordance with the dimensions and technical data supplied by the customer or by the Site Manager. Upon request, our own specialised personnel will survey the job and take the relevant measurements.

3. The price tables for the blind fabrics refer to finished dimensions of the blind (fabric drop = finished dimension + 20 cm for rolling and fixture to the tube). The "finished dimensions" define the overall dimensions for manufacture net of any tolerances for mounting and are used for all calculations regarding the invoice of the product. RESSTENDE declines all responsibility in relation to erroneous transmission of measurements by the customer.

4. TRANSPORT: delivery is intended carriage free, invoiced at 4% (minimum value 9.60 € VAT included), to the purchasers premises within the national territories. The goods travel without insurance at the purchasers own risk (Article 1693 Italian C.L.).

5. PACKAGING: included

6. TERMS OF DELIVERY: for "standard" products: delivery 2-3 weeks from date of receipt of our signed order confirmation; for "customised" orders and RAL colours not in stock: the delivery date will be communicated at the instant of ordering; in any circumstance the delivery date is to be intended as purely indicative and not binding. Any delays in delivery will not give rise to compensation, penalty or cancellation of the order unless stipulated by prior contractual agreement. Any claims made towards carriers and forwarding agents - for errors, taxes, delays, damage, breakage etc.- are the sole concern of the purchaser, exempting RESSTENDE Srl from any liability. Therefore at the instant of consignment of the goods, the purchaser must declare acceptance "with reserve" on the carrier/forwarder documents.

7. WARRANTY: is given for 2 (two) years parting from the date of consignment and is only valid for the material supplied, including all electric components. All electrical components must be correctly installed and connected to mains in accordance with EEC regulations and according to the installation and safety standards in force at the moment of the installation: otherwise the warranty will be considered void. During the period of warranty, liability will not be accepted for cost reimbursement in relation to repairs carried out directly by the purchaser prior to an on-site analysis by our personnel, or to our written authorisation. In all circumstances the warranty refers to manufacturing defects of the product and not to problems deriving from incorrect installation by third parties.

8. RECLAIMS: should be forwarded in writing within 8 (eight) days from receipt of the goods: otherwise they will not be taken into consideration. Restitution of goods will only be accepted if previously authorised in writing by RESSTENDE Srl; our liability is limited to the replacement of the defective goods, or parts of the goods, and excludes any right to cancel the order or to price reduction or to any compensation for damage. Charges such as transfer, dismantling, transport, re-installation etc, are excluded from the present warranty and can not therefore be debited to RESSTENDE. For products "installed" directly by RESSTENDE Srl, our qualified technician will evaluate the nature of the defects by means of an on-site inspection and will replace any components in warranty in the briefest time possible consented by such an operation.

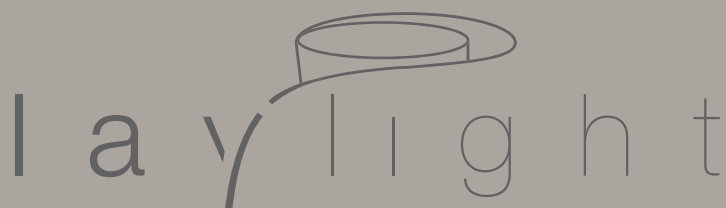

9. ORDER CANCELLATION: RESSTENDE Srl does not accept cancellations when the material is already in the process of being manufactured.

10. INVOICE : has effect from when the goods are ready for delivery and from the date of emission of the transport documents.

11. PAYMENT: the terms and the conditions of payment are those previously agreed upon and undersigned by both the purchaser and RESSTENDE Srl. For orders that include installation of the material, the payment term starts from the date of completion of the installation; in the eventuality of delays for causes not attributable to RESSTENDE Srl, we will however proceed with the invoice for the value of the material, the installation cost will later be invoiced upon completion of the project.

12. OVERDUE PAYMENT: if the agreed terms of payment are not respected, this will result in the application of an arrears interest rate corresponding to the current bank interest rate paid by RESSTENDE Srl.

13. INSTALLATION: The service offered for installation excludes the following activities: building, welding, preparation of the fixtures for the passage of the command system, electrical wiring and connection to mains supply: these activities are under the complete responsibility and liability of the purchaser. In addition, where necessary, the purchaser is obliged to supply suitable premises on site where the material to be installed may be stored, assuming all responsibility for its integrity and conservation. The purchaser must ensure that the technicians are put in the condition to carry out the installation without interruption: non-operative periods of our personnel will be charged and invoiced upon completion.

14. TESTING: unless otherwise agreed, the installed products should be connected and duly tested within 10 (ten) days from termination of the installation. Upon termination of the installation a report form should be completed by our installers and undersigned by the purchaser, or by the site manager. The purchaser, in undersigning this report, certifies that the installation has been correctly carried out and gives his consent for invoicing.

15. All disputes or legal proceedings shall be submitted to the jurisdiction of the Milan law courts.

Guida alla lettura - Guide to the reading

I.V.A. INCLUSA

Le tabelle dei prezzi sono in Euro (€). Per calcolare il prezzo di misure intermedie si intende valida la misura immediatamente successiva nelle tabelle prezzi. Ogni tabella prezzi ha un'immagine di riferimento per consentire una rapida individuazione della tenda richiesta. Nelle ultime pagine del listino, sono riportate le tabelle di utilizzo dei tessuti e il modulo d'ordine. Ricordiamo che i termini di consegna per i prodotti sono 2-3 settimane dal ricevimento della nostra conferma d'ordine firmata.

INDICAZIONI RICHIESTE AL CLIENTE PER LA TRASMISSIONE DI UN ORDINE (Si prega di usare l'apposito modulo in fondo al listino):

- Misura di riferimento L x H telo finito in cm.
- Tipologia di modello scelto
- Tipo di manovra e lato manovra
- Finitura della struttura
- Tessuto scelto

VAT INCLUDED

The price tables are shown in Euro (€). To calculate the price for intermediate sizes you should use the next dimension up. Every table of the price list has its image to allow a quick view of the required blind model. The last pages of the price list show a reference table to the different fabrics. We wish to remind our customers that the terms of delivery for products is 2-3 weeks from receipt of our signed order confirmation.

INFORMATION REQUIRED FOR TRANSMISSION OF ORDER (Please use order sheet at back of price list):

- Overall fabric dimensions W x H in cm.
- Type of model choice
- Type and side of operation
- Aluminium finishing
- Fabric choice

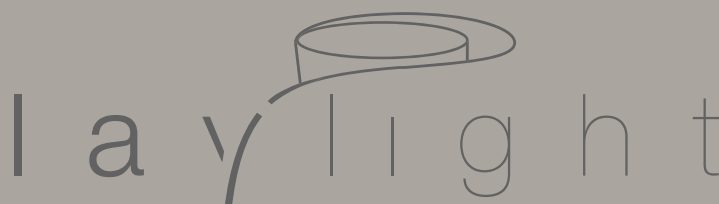

Laylight

INDICE

Condizioni di vendita

SINTESI Sinuoso - Deciso (Standard)	01
SINTESI Sinuoso - Deciso (XL)	03
LINEO Dritta	05
LINEO Obliqua	07

INDEX

General terms and conditions of sale

SINTESI Sinuoso - Deciso (Standard)	01
SINTESI Sinuoso - Deciso (XL)	03
LINEO Dritta	05
LINEO Obliqua	07

SINTESI Sinuoso - Deciso

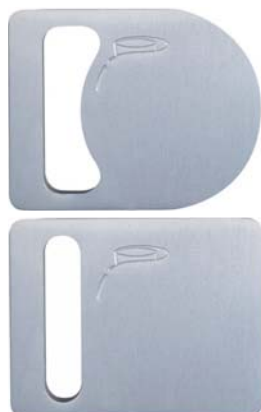

STANDARD SATINATA - SATINIZED

L 100	L 120	L 140	L 160	L 180	L 200	L 220	L 240	L 260
266 €	275 €	285 €	291 €	303 €	307 €	322 €	326 €	340 €

Prezzi IVA inclusa / VAT included



STANDARD LUCIDA - POLISHED

L 100	L 120	L 140	L 160	L 180	L 200	L 220	L 240	L 260
345 €	357 €	370 €	378 €	393 €	399 €	418 €	423 €	442 €

Prezzi IVA inclusa / VAT included



STANDARD CROMATA - CHROME

L 100	L 120	L 140	L 160	L 180	L 200	L 220	L 240	L 260
478 €	495 €	513 €	523 €	545 €	552 €	579 €	566 €	612 €

Prezzi IVA inclusa / VAT included

Fondale - Bottom rail



CM/76038
Satinato-Satinized

CM/76083
Lucido-Polished

CM/76039
Cromato-Chrome

CM/76034
Satinato-Satinized

CM/76085
Lucido-Polished

CM/76035
Cromato-Chrome

Tappo fondale - Bottom rail end cap



CM/76040
Satinato-Satinized

CM/76087
Lucido-Polished

CM/76041
Cromato-Chrome

CM/76036
Satinato-Satinized

CM/76089
Lucido-Polished

CM/76037
Cromato-Chrome

INGOMBRI

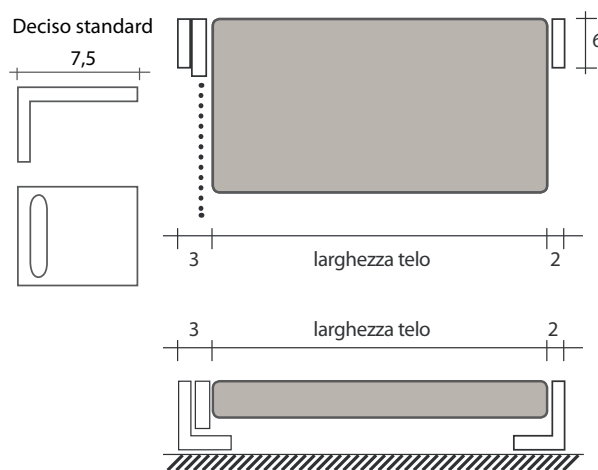
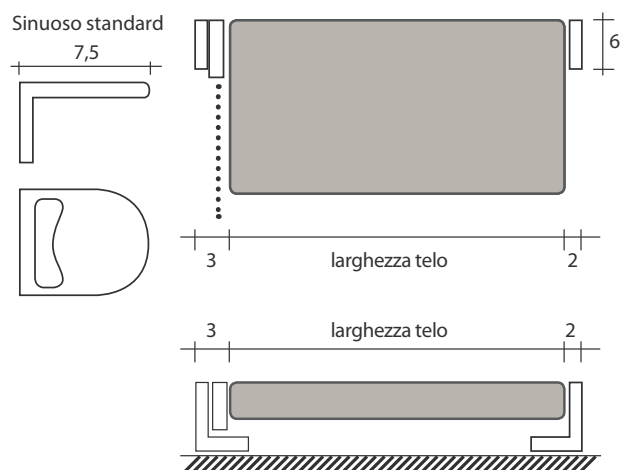

Note

- Campione per esposizione DA DEFINIRE

SINTESI Sinuoso - Deciso



XL SATINATA - XL SATINIZED

L 100	L 120	L 140	L 160	L 180	L 200	L 220	L 240	L 260
278 €	287 €	297 €	303 €	315 €	319 €	334 €	338 €	352 €

Prezzi IVA inclusa / VAT included



XL LUCIDA - XL POLISHED

L 100	L 120	L 140	L 160	L 180	L 200	L 220	L 240	L 260
357 €	369 €	382 €	390 €	405 €	411 €	430 €	435 €	454 €

Prezzi IVA inclusa / VAT included



XL CROMATA - XL CHROME

L 100	L 120	L 140	L 160	L 180	L 200	L 220	L 240	L 260
490 €	507 €	525 €	535 €	557 €	564 €	591 €	598 €	624 €

Prezzi IVA inclusa / VAT included

Fondale - Bottom rail



CM/76038
Satinato-Satinized

CM/76083
Lucido-Polished

CM/76039
Cromato-Chrome

CM/76034
Satinato-Satinized

CM/76085
Lucido-Polished

CM/76035
Cromato-Chrome

Tappo fondale - Bottom rail end cap

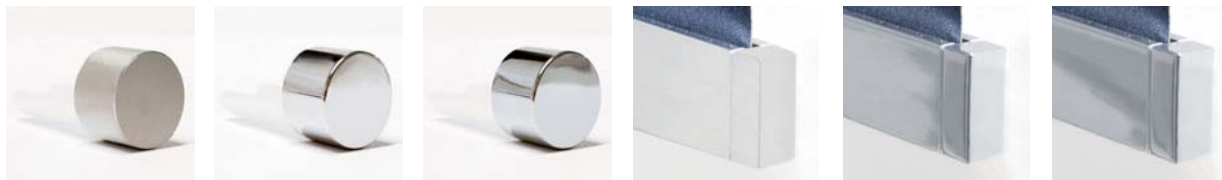

CM/76040
Satinato-Satinized

CM/76087
Lucido-Polished

CM/76041
Cromato-Chrome

CM/76036
Satinato-Satinized

CM/76089
Lucido-Polished

CM/76037
Cromato-Chrome

INGOMBRI

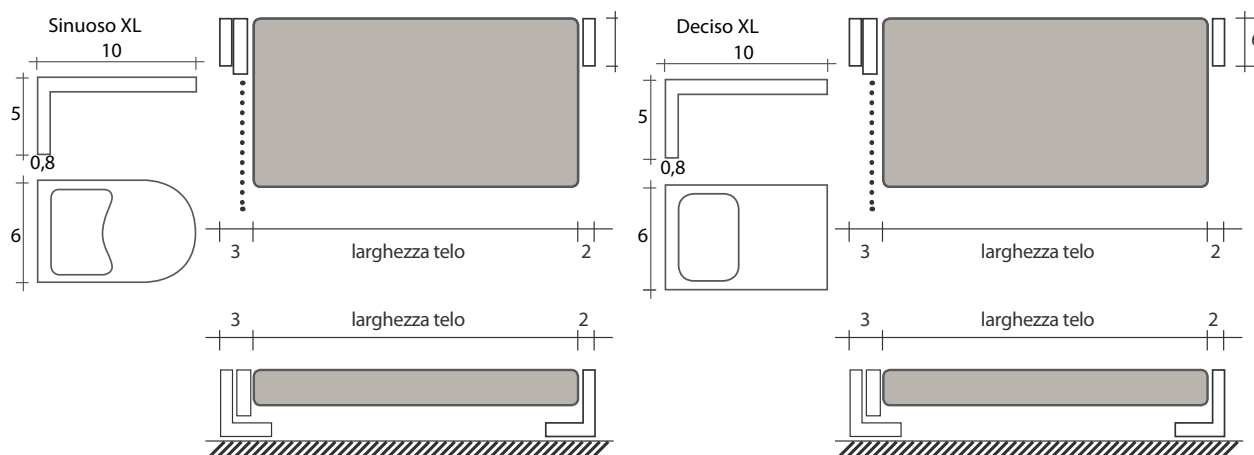

Note

- Possibilità di scelta: finali mantovana - fondale - tappo fondale
- Supplemento chiusura angolo DA DEFINIRE
- Supplemento motore a batteria (pile incluse) 560,00 €
- Campione per esposizione DA DEFINIRE

LINEO Dritto



SATINATA - SATINIZED

L 100	L 120	L 140	L 160	L 180	L 200	L 220	L 240	L 260
478 €	517 €	530 €	544 €	561 €	572 €	585 €	599 €	613 €

Prezzi IVA inclusa / VAT included



LUCIDA - POLISHED

L 100	L 120	L 140	L 160	L 180	L 200	L 220	L 240	L 260
622 €	672 €	689 €	707 €	729 €	743 €	761 €	778 €	796 €

Prezzi IVA inclusa / VAT included



CROMATA - CHROME

L 100	L 120	L 140	L 160	L 180	L 200	L 220	L 240	L 260
869 €	929 €	953 €	979 €	1009 €	1029 €	1053 €	1078 €	1102 €

Prezzi IVA inclusa / VAT included

Finali per mantovana -



CM/76011
Satinato-Satinized



CM/76069
Lucido-Polished



CM/76071
Cromato-Chrome



CM/76012
Ciliegio-Cherry wood



CM/76013
Wengè

Fondale - Bottom rail



CM/76038
Satinato-Satinized



CM/76083
Lucido-Polished



CM/76039
Cromato-Chrome



CM/76034
Satinato-Satinized

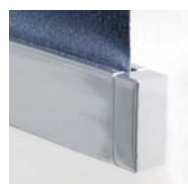

CM/76085
Lucido-Polished



CM/76035
Cromato-Chrome

Tappo fondale - Bottom rail end cap



CM/76040
Satinato-Satinized



CM/76087
Lucido-Polished



CM/76041
Cromato-Chrome



CM/76036
Satinato-Satinized



CM/76089
Lucido-Polished



CM/76037
Cromato-Chrome

INGOMBRI

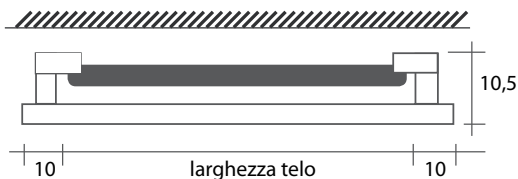
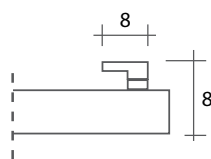

Attacco a soffitto
Ceiling mounting

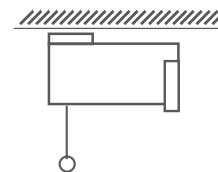

Attacco a parete
Wall mounting

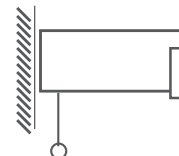

Note

- Possibilità di scelta: finali mantovana - fondale - tappo fondale
- Supplemento chiusura angolo DA DEFINIRE
- Supplemento motore a batteria (pile incluse) 560,00 €
- Supporto intermedio per tenda doppio modulo DA DEFINIRE
- Campione per esposizione DA DEFINIRE

LINEO Obliquo



SATINATA - SATINIZED

L 100	L 120	L 140	L 160	L 180	L 200	L 220	L 240	L 260
493 €	532 €	545 €	559 €	576 €	587 €	600 €	614 €	628 €

Prezzi IVA inclusa / VAT included



LUCIDA - POLISHED

L 100	L 120	L 140	L 160	L 180	L 200	L 220	L 240	L 260
637 €	687 €	704 €	722 €	744 €	758 €	776 €	793 €	811 €

Prezzi IVA inclusa / VAT included



CROMATA - CHROME

L 100	L 120	L 140	L 160	L 180	L 200	L 220	L 240	L 260
884 €	944 €	968 €	994 €	1024 €	1044 €	1068 €	1093 €	1117 €

Prezzi IVA inclusa / VAT included

Finali per mantovana



CM/76015
Satinato-Satinized

CM/76071
Lucido-Polished

CM/76031
Cromato-Chrome

Fondale - Bottom rail



CM/76038
Satinato-Satinized

CM/76083
Lucido-Polished

CM/76039
Cromato-Chrome

CM/76034
Satinato-Satinized

CM/76085
Lucido-Polished

CM/76035
Cromato-Chrome

Tappo fondale - Bottom rail end cap



CM/76040
Satinato-Satinized

CM/76087
Lucido-Polished

CM/76041
Cromato-Chrome

CM/76036
Satinato-Satinized

CM/76089
Lucido-Polished

CM/76037
Cromato-Chrome

INGOMBRI

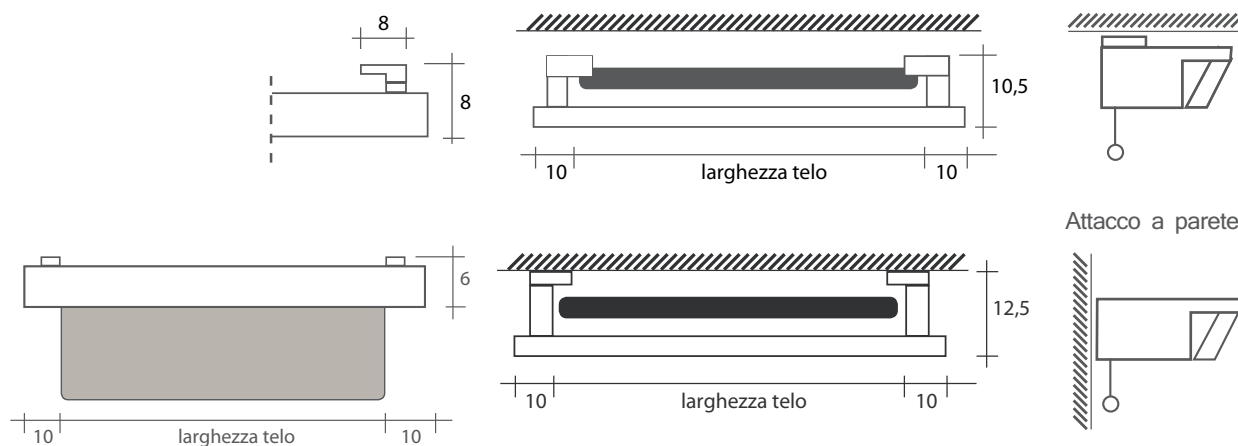

Note

- Possibilità di scelta: finali mantovana - fondale - tappo fondale
- Supplemento chiusura angolo DA DEFINIRE
- Supplemento motore a batteria (pile incluse) 560,00 €
- Campione per esposizione DA DEFINIRE



TESSUTI

Dream

Misure tenda finita

H/L	L 100	L 120	L 140	L 160	L 180	L 200	L 220	L 240	L 260
H 100	72 €	82 €	92 €	102 €	112 €	121 €	131 €	140 €	151 €
H 110	76 €	86 €	97 €	108 €	118 €	128 €	139 €	150 €	161 €
H 120	79 €	91 €	102 €	114 €	125 €	136 €	148 €	158 €	170 €
H 130	83 €	96 €	108 €	119 €	131 €	143 €	155 €	168 €	179 €
H 140	88 €	100 €	113 €	125 €	138 €	151 €	163 €	176 €	188 €
H 150	91 €	104 €	118 €	131 €	145 €	158 €	172 €	185 €	198 €
H 160	95 €	108 €	122 €	137 €	151 €	166 €	180 €	194 €	208 €
H 170	98 €	113 €	128 €	143 €	157 €	173 €	187 €	203 €	217 €
H 180	102 €	118 €	133 €	149 €	164 €	180 €	196 €	211 €	227 €
H 190	106 €	122 €	138 €	155 €	172 €	187 €	204 €	221 €	236 €
H 200	109 €	126 €	143 €	161 €	178 €	194 €	212 €	229 €	246 €
H 210	113 €	131 €	149 €	167 €	185 €	202 €	220 €	238 €	256 €
H 220	116 €	136 €	154 €	173 €	191 €	210 €	228 €	247 €	265 €
H 230	120 €	139 €	158 €	178 €	198 €	217 €	236 €	256 €	275 €
H 240	124 €	144 €	164 €	184 €	204 €	224 €	244 €	264 €	284 €
H 250	127 €	149 €	169 €	190 €	211 €	232 €	252 €	274 €	294 €
H 260	131 €	152 €	174 €	196 €	217 €	239 €	260 €	282 €	304 €
H 270	134 €	157 €	179 €	202 €	224 €	246 €	269 €	290 €	313 €
H 280	138 €	162 €	185 €	208 €	230 €	253 €	276 €	300 €	323 €
H 290	142 €	166 €	190 €	214 €	238 €	260 €	284 €	308 €	332 €
H 300	146 €	170 €	194 €	220 €	244 €	268 €	293 €	317 €	342 €

Prezzi IVA inclusa

Idea Screen

Misure tenda finita

H/L	L 100	L 120	L 140	L 160	L 180	L 200	L 220	L 240	L 260
H 100	80 €	90 €	102 €	113 €	124 €	135 €	147 €	158 €	168 €
H 110	83 €	95 €	107 €	119 €	131 €	143 €	154 €	166 €	178 €
H 120	87 €	100 €	112 €	125 €	143 €	150 €	162 €	176 €	188 €
H 130	90 €	104 €	117 €	130 €	143 €	158 €	171 €	184 €	197 €
H 140	94 €	101 €	123 €	136 €	150 €	165 €	178 €	192 €	207 €
H 150	98 €	112 €	128 €	142 €	156 €	172 €	186 €	201 €	216 €
H 160	101 €	117 €	132 €	148 €	164 €	179 €	195 €	210 €	225 €
H 170	105 €	122 €	137 €	154 €	170 €	186 €	202 €	219 €	234 €
H 180	108 €	125 €	142 €	160 €	177 €	194 €	210 €	227 €	244 €
H 190	112 €	130 €	148 €	165 €	183 €	201 €	219 €	236 €	254 €
H 200	116 €	135 €	153 €	171 €	190 €	208 €	226 €	245 €	263 €
H 210	119 €	138 €	158 €	177 €	196 €	215 €	234 €	254 €	273 €
H 220	123 €	143 €	162 €	183 €	202 €	222 €	243 €	262 €	282 €
H 230	126 €	147 €	168 €	189 €	209 €	230 €	250 €	270 €	291 €
H 240	130 €	152 €	173 €	195 €	215 €	237 €	258 €	280 €	300 €
H 250	134 €	156 €	178 €	200 €	222 €	244 €	266 €	288 €	310 €
H 260	137 €	160 €	183 €	206 €	228 €	251 €	274 €	297 €	320 €
H 270	141 €	165 €	188 €	212 €	236 €	258 €	282 €	305 €	329 €
H 280	144 €	170 €	194 €	218 €	242 €	266 €	290 €	315 €	339 €
H 290	148 €	173 €	198 €	224 €	249 €	273 €	298 €	323 €	348 €
H 300	152 €	178 €	203 €	230 €	255 €	280 €	306 €	332 €	357 €

Prezzi IVA inclusa

Natura

Misure tenda finita

H/L	L 100	L 120	L 140	L 160	L 180	L 200	L 220	L 240
H 100	84 €	96 €	108 €	121 €	133 €	145 €	157 €	170 €
H 110	89 €	109 €	116 €	130 €	143 €	156 €	169 €	182 €
H 120	95 €	109 €	124 €	138 €	152 €	167 €	181 €	196 €
H 130	100 €	115 €	131 €	146 €	162 €	178 €	193 €	209 €
H 140	106 €	122 €	138 €	155 €	172 €	188 €	204 €	221 €
H 150	110 €	128 €	146 €	163 €	181 €	198 €	216 €	234 €
H 160	116 €	136 €	154 €	172 €	191 €	209 €	228 €	246 €
H 170	122 €	142 €	161 €	181 €	200 €	220 €	239 €	259 €
H 180	127 €	148 €	169 €	190 €	210 €	230 €	251 €	271 €
H 190	133 €	155 €	176 €	198 €	220 €	241 €	263 €	284 €
H 200	138 €	161 €	184 €	206 €	229 €	252 €	275 €	296 €
H 210	144 €	168 €	191 €	215 €	239 €	263 €	286 €	310 €
H 220	149 €	174 €	199 €	228 €	248 €	272 €	298 €	323 €
H 230	155 €	180 €	206 €	232 €	258 €	283 €	310 €	335 €
H 240	161 €	187 €	214 €	241 €	268 €	294 €	320 €	348 €
H 250	166 €	193 €	222 €	250 €	277 €	305 €	332 €	360 €
H 260	172 €	200 €	229 €	258 €	287 €	316 €	344 €	373 €
H 270	176 €	206 €	236 €	266 €	296 €	326 €	356 €	385 €
H 280	182 €	214 €	244 €	275 €	306 €	337 €	367 €	398 €
H 290	187 €	220 €	252 €	283 €	316 €	347 €	379 €	412 €

Prezzi IVA inclusa

Colortex

Misure tenda finita

H/L	L100	L120	L140	L160	L180	L200	L220	L240	L260
H 100	44 €	52 €	59 €	65 €	72 €	78 €	85 €	92 €	98 €
H 110	48 €	55 €	62 €	70 €	77 €	84 €	91 €	98 €	107 €
H 120	50 €	59 €	66 €	74 €	82 €	90 €	98 €	106 €	114 €
H 130	53 €	61 €	70 €	78 €	88 €	96 €	104 €	113 €	121 €
H 140	56 €	65 €	74 €	83 €	92 €	101 €	110 €	120 €	128 €
H 150	59 €	68 €	78 €	88 €	97 €	107 €	116 €	126 €	136 €
H 160	61 €	72 €	82 €	92 €	102 €	113 €	122 €	133 €	143 €
H 170	65 €	76 €	86 €	97 €	108 €	119 €	130 €	139 €	150 €
H 180	67 €	78 €	90 €	101 €	113 €	124 €	136 €	146 €	158 €
H 190	70 €	82 €	94 €	106 €	118 €	130 €	142 €	154 €	166 €
H 200	73 €	85 €	98 €	110 €	122 €	136 €	148 €	160 €	173 €
H 210	76 €	89 €	102 €	115 €	128 €	140 €	154 €	167 €	180 €
H 220	78 €	92 €	106 €	120 €	133 €	146 €	160 €	174 €	187 €
H 230	82 €	96 €	109 €	124 €	138 €	152 €	167 €	180 €	194 €
H 240	84 €	98 €	114 €	128 €	143 €	158 €	173 €	187 €	202 €
H 250	88 €	102 €	118 €	133 €	149 €	163 €	179 €	194 €	210 €
H 260	90 €	106 €	121 €	138 €	154 €	169 €	185 €	200 €	217 €
H 270	92 €	109 €	126 €	142 €	158 €	175 €	191 €	208 €	224 €
H 280	96 €	113 €	130 €	146 €	163 €	180 €	198 €	215 €	232 €
H 290	98 €	116 €	133 €	151 €	169 €	186 €	204 €	221 €	239 €
H 300	101 €	120 €	138 €	156 €	174 €	192 €	210 €	228 €	246 €

Prezzi IVA inclusa

Nome Cliente: _____ Date: _____

Ordine Preventivo

<p>SINUOSO <input type="checkbox"/></p> 	Staffa	Attacco	Fondale	Comando
	Standard <input type="checkbox"/>	Soffitto <input type="checkbox"/>	Tondo <input type="checkbox"/>	Catena <input type="checkbox"/>
	XL <input type="checkbox"/>	Parete <input type="checkbox"/>	Quadro <input type="checkbox"/>	Motore a batteria <input type="checkbox"/>
	Satinato <input type="checkbox"/>	Tappo fondale		Manovra
	Lucido <input type="checkbox"/>	Satinato <input type="checkbox"/>	Satinato <input type="checkbox"/>	DX <input type="checkbox"/> SX <input type="checkbox"/>
	Cromato <input type="checkbox"/>	Lucido <input type="checkbox"/>	Lucido <input type="checkbox"/>	
		Cromato <input type="checkbox"/>	Cromato <input type="checkbox"/>	
Q.	Misure L-H cm	H catena	Cod. Tessuto	

<p>DECISO <input type="checkbox"/></p> 	Glazed <input type="checkbox"/>	Lucida <input type="checkbox"/>
	Chrome <input type="checkbox"/>	

<p>LINEO Dritta <input type="checkbox"/></p> 	Finale	Attacco	Fondale	Comando
	Satinato <input type="checkbox"/>	Soffitto <input type="checkbox"/>	Tondo <input type="checkbox"/>	Catena <input type="checkbox"/>
	Lucido <input type="checkbox"/>	Parete <input type="checkbox"/>	Quadro <input type="checkbox"/>	Motore a batteria <input type="checkbox"/>
	Chrome <input type="checkbox"/>	Bottom rail end cap		Manovra
	Cliegio (solo per LINEO dritta) <input type="checkbox"/>	Satinato <input type="checkbox"/>	Satinato <input type="checkbox"/>	R <input type="checkbox"/> L <input type="checkbox"/>
	Wengè (Solo per LINEO dritta) <input type="checkbox"/>	Lucido <input type="checkbox"/>	Lucido <input type="checkbox"/>	
		Cromato <input type="checkbox"/>	Cromato <input type="checkbox"/>	
Q.	Misure L-H cm	H catena	Cod. Tessuto	

<p>LINEO Obliqua <input type="checkbox"/></p> 	Satinata <input type="checkbox"/>	Lucida <input type="checkbox"/>
	Cromata <input type="checkbox"/>	

Customer name _____ Date: _____

Order

Quotation

		Bracket	Mounting	Bottom rail	Operation
<p>SINUOSO <input type="checkbox"/></p> 	Standard	<input type="checkbox"/>	Ceiling <input type="checkbox"/>	Round <input type="checkbox"/>	Chain <input type="checkbox"/>
	XL	<input type="checkbox"/>	Wall <input type="checkbox"/>	Square <input type="checkbox"/>	Motor battery <input type="checkbox"/>
	Satinized	<input type="checkbox"/>	Tappo fondale		Operation side DX <input type="checkbox"/> SX <input type="checkbox"/>
	Polished	<input type="checkbox"/>	Satinized <input type="checkbox"/>	Satinized <input type="checkbox"/>	
	Chrome	<input type="checkbox"/>	Polished <input type="checkbox"/>	Polished <input type="checkbox"/>	
		Chrome <input type="checkbox"/>	Chrome <input type="checkbox"/>		
Q.	Dimensions W x H cm		Chain H		Fabric code
Satinized <input type="checkbox"/>	Polished <input type="checkbox"/>				
Chrome <input type="checkbox"/>					

		End cap	Mounting	Bottom rail	Operation
<p>LINEO Dritta <input type="checkbox"/></p> 	Satinized	<input type="checkbox"/>	Ceiling <input type="checkbox"/>	Round <input type="checkbox"/>	Chain <input type="checkbox"/>
	Polished	<input type="checkbox"/>	Wall <input type="checkbox"/>	Square <input type="checkbox"/>	Battery motor <input type="checkbox"/>
	Chrome	<input type="checkbox"/>	Bottom rail end cap		Operation side R <input type="checkbox"/> L <input type="checkbox"/>
	Cherry wood <small>(Only for LINEO dritta)</small>	<input type="checkbox"/>	Satinized <input type="checkbox"/>	Satinized <input type="checkbox"/>	
	Wengè <small>(Only for LINEO dritta)</small>	<input type="checkbox"/>	Polished <input type="checkbox"/>	Polished <input type="checkbox"/>	
		Chrome <input type="checkbox"/>	Chrome <input type="checkbox"/>	Chrome <input type="checkbox"/>	
Q.	Dimensions W x H cm		Chain H		Fabric code
Satinized <input type="checkbox"/>	Polished <input type="checkbox"/>				
Chrome <input type="checkbox"/>					

l a y  l i g h t

Resstende S.r.l. Via Ghiringhella 74 - 20041 Agrate Brianza (MB) Italy - Tel. +39 039 684611 (Italy) - Ph. +39 039 6846145 (export)
info@resstende.com - www.laylight.it